

ZGRADE

Mario Širić

2020+

Energetska učinkovitost
i održivost zgrada nakon
2020.

Upravljanje grijanjem nekada i sada

Početak.....



18 st. – ručno
upravljanje

....danas
21. st. IoT

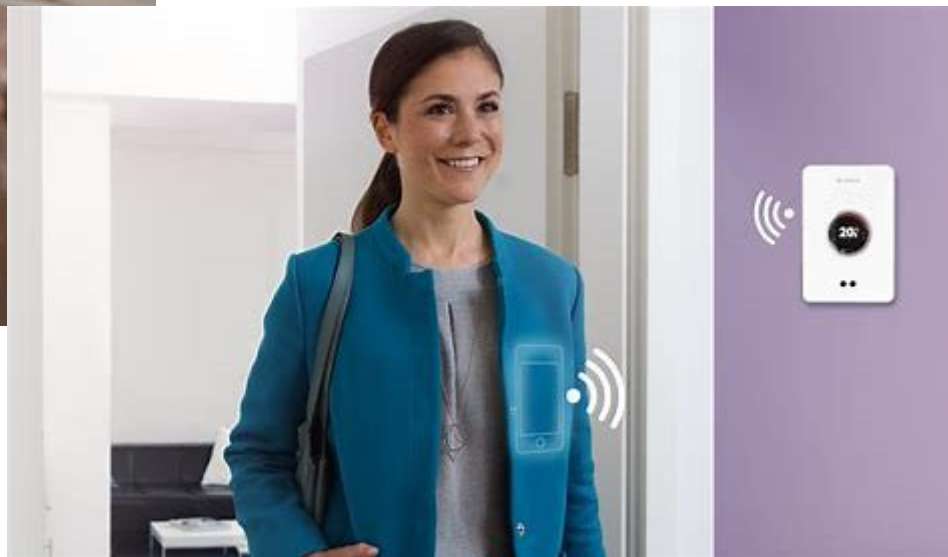

Industrijski kotlovi nekada i sada



Parni
kotao

Bosch Easy Control



Bosch EasyControl

Što je EasyControl?

- ▶ Upravljanje grijanjem preko EMS-BUS
- ▶ Za upravljanje grijanjem stanova ili obiteljskih kuća
- ▶ Upravljanje jednog kruga grijanja
- ▶ Upravljanje toplom vodom
- ▶ Upravljanje grijanjem i internet ulaz u jednom uređaju
- ▶ Brojna pametna rješenja za visoku učinkovitost i komfort



EasyControl of Bosch

Hardware

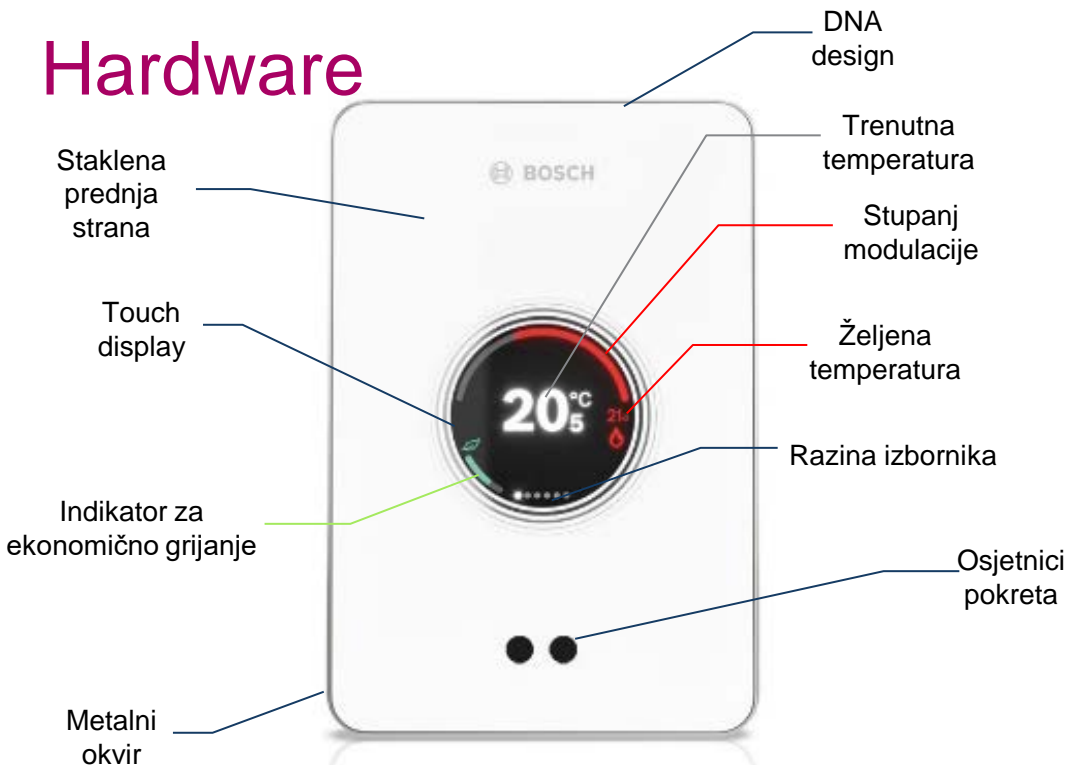

 **BOSCH**



editing, distribution, as well as in the event of applications for industrial property rights.

 **BOSCH**

Bosch EasyControl

Potrebna oprema

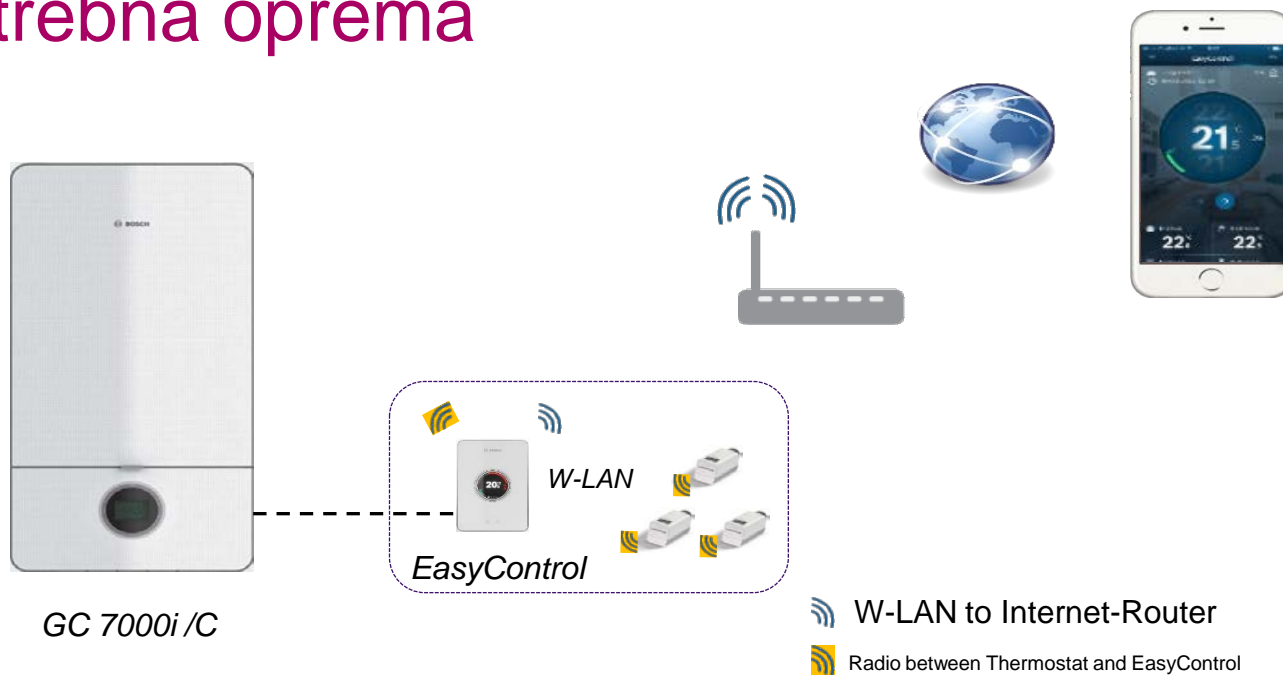

Upravlajte svojim grijanjem iz bilo kojeg mjesta u svijetu

Bosch EasyControl

Pametno otkrivanje prisutnost

- ▶ Grijanje samo ako treba (detekcija u krugu 50 m)
- ▶ Smanjenje troškova grijanja do 20%
- ▶ Fleksibilna alternativa umjesto fiksnih vremena

Novi pametan algoritam ima nekoliko funkcija:

Geofencing (Distance detection)

Pozicija pametnog telefona preko GPSa and W-LANa pamti kretanje i kalkulira moguće vrijeme dolaska.

Mjesto zadržavanja

Mjesto čestog zadržavanja se pamti. Redovna posjeta teretane svakog utorka i četvrtka.

Pametno predgrijavanje

Optimizacija klasičnog vremenskog programa. Pokretanje predgrijanja prema mjerenom vremenu potrebno za grijanje objekta.



Bosch EasyControl

Pametno tuširanje

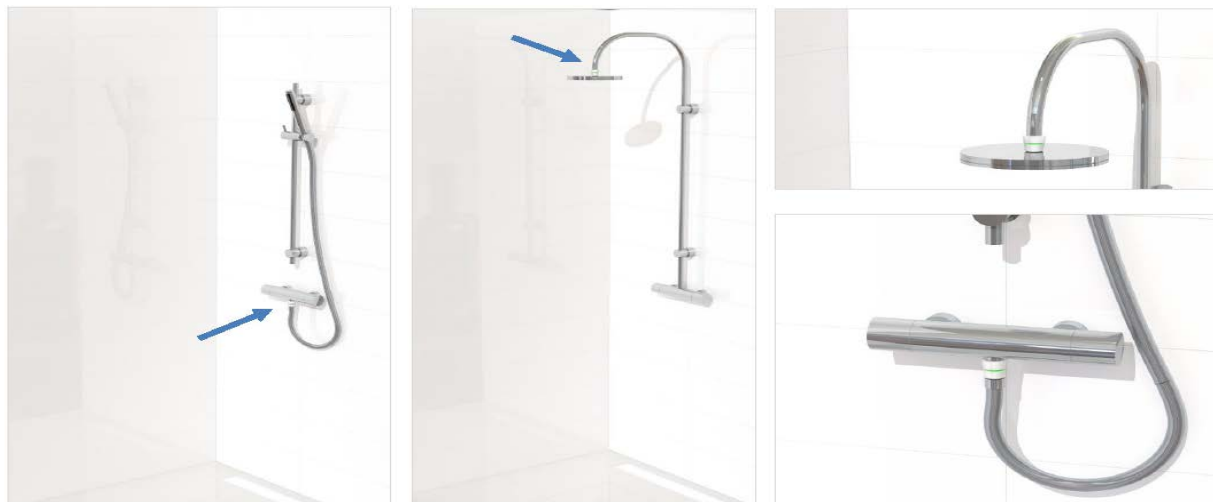

Pamti navike tuširanja

Bosch EasyControl

Konfiguracija s vanjskom temperaturom

- ▶ Utjecaj prostorije određuje faktor paralelnog podešavanja
- ▶ Zadana vrijednost je osnovna vrijednost za sobnu temperaturu

Example calculation for determining the parallel adjustment

Parameter Room temperature: current 16°C Set point 20°C Room influence factor: 2 - middle (house inertance)

Berechnung (set point - current) × influence factor = **parallel adjustment**

$(20^{\circ}\text{C} - 16^{\circ}\text{C}) \times 2\text{K} = +8\text{K}$ parallel adjustment higher,
 $V_{L\text{Temp}} = 46^{\circ}\text{C}$ instead of 38°C

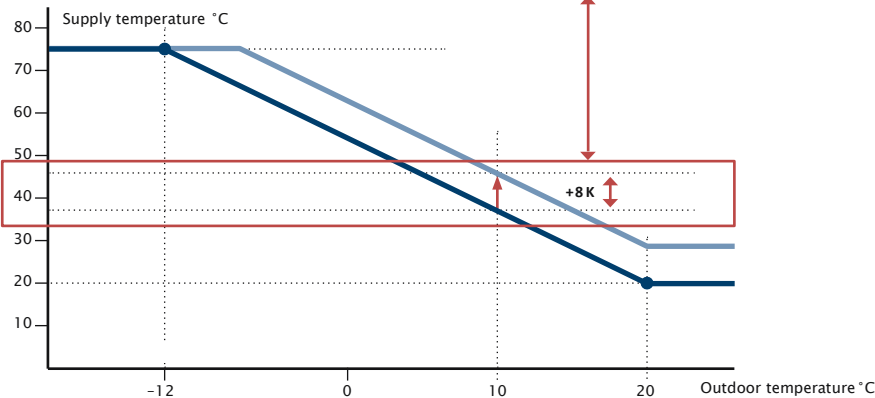

Metereološka stanica

Bosch EasyControl

Eco Bar – simply smart

- ▶ Obavijest korisniku o efikasnosti podešenih postavki.
- ▶ Kalkulacija uključuje:
 - ▶ Sobnu temperaturu
 - ▶ PTV
 - ▶ Smart Shower (Acc.)
- ▶ **Eco-Bar kalkulira dvije vrijednosti:**
 - ▶ PTV mode (on/off)
 - ▶ Zadana temperatura (devijacija u %)

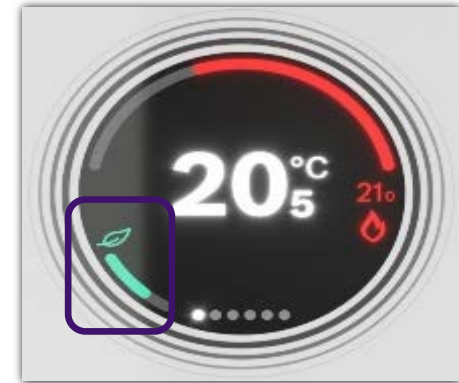

Touch-Display at EasyControl

Bosch EasyControl

Pregled konzumacije

- ▶ Izvještaj o potrošnji na tjednoj/mjesečnoj/godišnjoj razini
- ▶ Podjela pregleda na grijanje i PTV
- ▶ Podešavanje maksimalnog vremena za tuširanje
- ▶ Podešavanje maksimalnog iznosa predviđenog za grijanje



Konzumacija plina



Ukupno

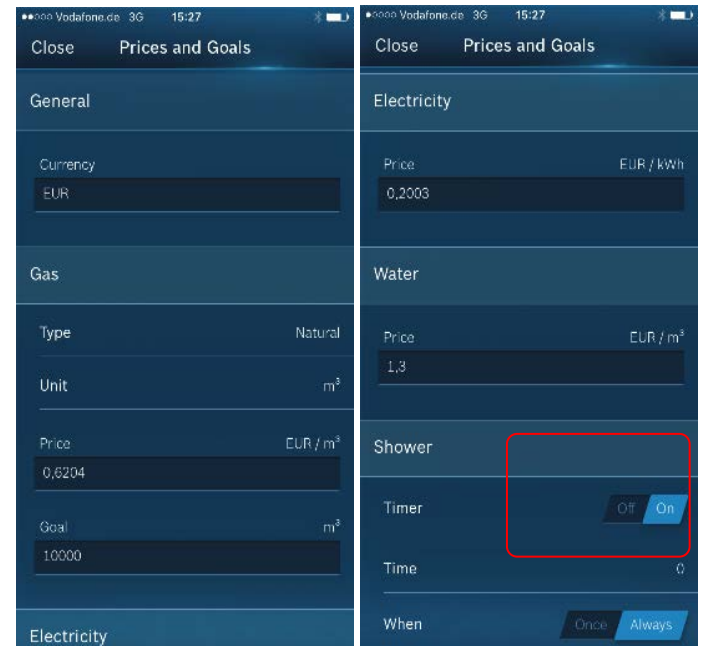

Uredi cijenu i mjerač vremena za tuširanje

Bosch EasyControl

Pametni termostati: Neovisna regulacije svake prostorije

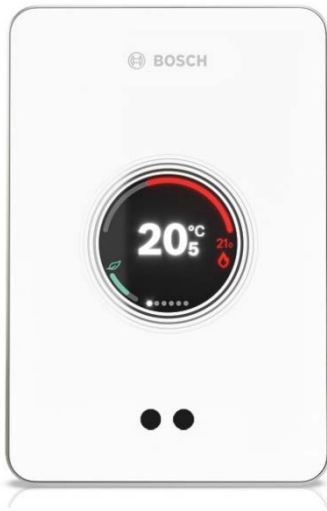

Radijatorski termostat s bežičnom vezom za regulaciju temperature pojedinačnih prostorija i vremensko upravljanje za Bosch Easy Control (do 19 kom.)

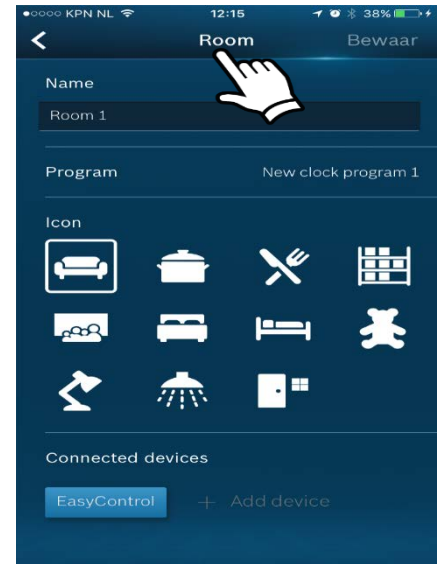

Bosch EasyControl

NOVO!!! Easy controll adapter



Adapter omogućuje daljinsko upravljanje plinskim uređajima neovisno o marki i tipu uređaja

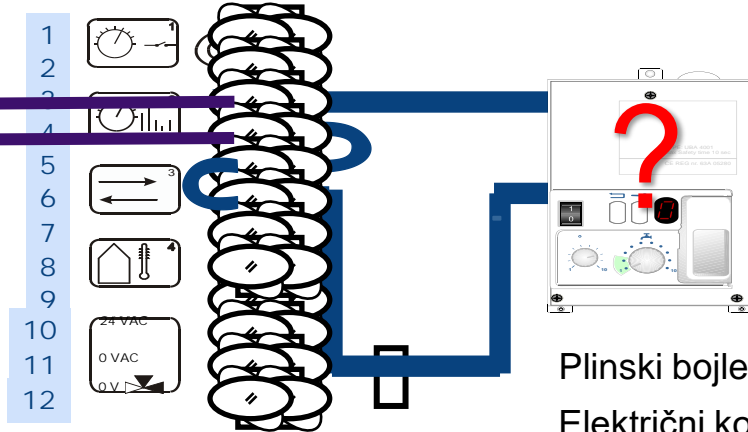

Plinski bojler
Električni kotao
Peletni kotao

Referenca



Sarajevo – Poljine Hills Resort

Urbano naselje 180 vila

Zahvaljujemo na Vašoj pozornosti!

